

STANDARD TYPE

規

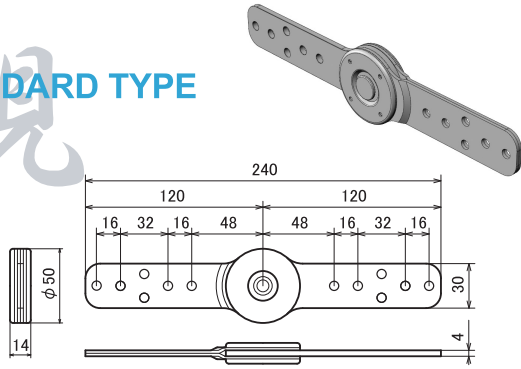

12
STEPS

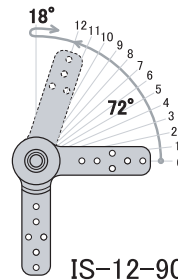

IS-12-90
zero position= 90°
end position= 162°

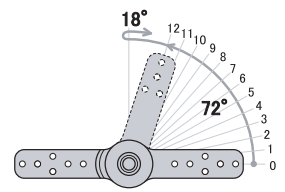

IS-12-180
zero position=180°
end position= 252°

5
STEPS

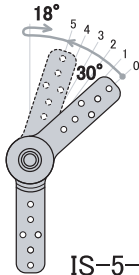

IS-5-132
zero position=132°
end position= 162°

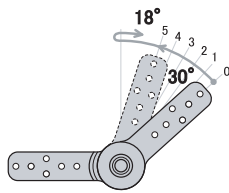

IS-5-222
zero position=222°
end position= 252°

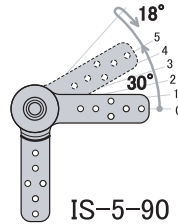

IS-5-90
zero position= 90°
end position= 120°

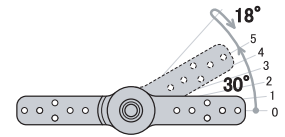

IS-5-180
zero position=180°
end position= 210°

8
STEPS

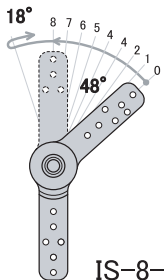

IS-8-132
zero position= 132°
end position= 180°

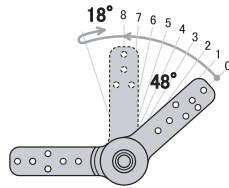

IS-8-222
zero position=222°
end position= 270°

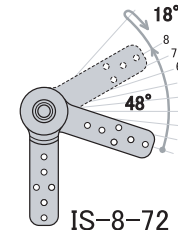

IS-8-72
zero position= 72°
end position= 120°

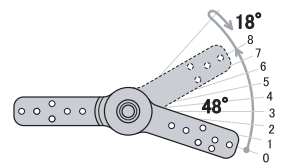

IS-8-162
zero position=162°
end position= 210°

9
STEPS

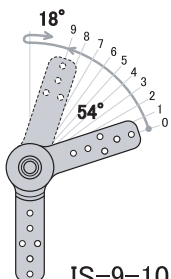

IS-9-108
zero position= 108°
end position= 162°

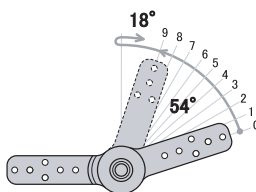

IS-9-198
zero position=198°
end position= 252°

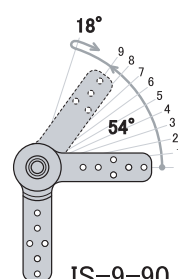

IS-9-90
zero position= 90°
end position= 144°

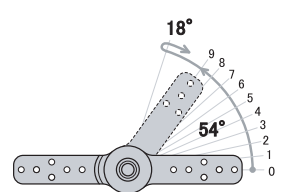

IS-9-180
zero position=180°
end position= 234°

15
STEPS

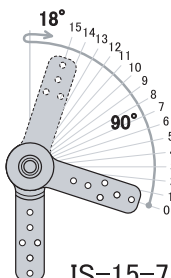

IS-15-72
zero position= 72°
end position= 162°

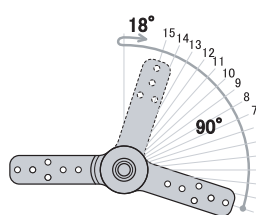

IS-15-162
zero position=162°
end position= 252°

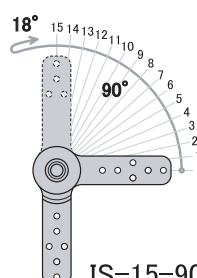

IS-15-90
zero position= 90°
end position= 180°

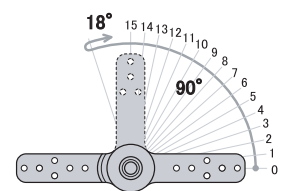

IS-15-180
zero position=180°
end position= 270°